

POLYMAX

Leaders in rubber technology



Fenders and Impact Catalogue

Buy Direct Online Today at www.polymax.co.uk

E: sales@polymax.co.uk

T: +44 (0)1420 550598

W: www.polymax.co.uk



Welcome to the Polymax Fender and Impact Catalogue

In this catalogue you'll find our complete range of fenders and high-impact protection bumpers including standard rubber and PVC D-Fenders, HGV and Dock Bumpers. We're taking the guesswork out of procurement by including detailed technical drawings, online datasheets and the ability to purchase every item online to give you the best buying experience from start to finish.

If you can't find what you're looking for, or just want some friendly advice, get in touch with our sales team. Remember, if it's made of rubber, we can supply it.

Corporate Head Office

Hampshire, England, United Kingdom

E: sales@polymax.co.uk
T: +44 (0)1420 550598
W: www.polymax.co.uk

Polymax India

E: sales@polymax.in
T: +91 (0)7678 005003
W: www.polymax.in

WORLDWIDE CUSTOMER SUPPORT TEAM

Polymax Polska

E: biuro@polimaxpolska.pl
T: +48 22 208 4400
W: www.polymax.pl

Polymax Nederland

E: sales@oringen.eu
T: +31 70 250 0606
W: www.oringen.eu

Sales terms and conditions apply visit www.polymax.co.uk/sales-terms. All measurements are subject to ±5% tolerance.

Contents



D-Fenders

Pages 4-9

Standard Rubber D-Fenders	Page 6
White PVC D-Fenders	Page 7
Black PVC D-Fenders	Page 8
Black PVC B-Fenders	Page 9
TPE D-Fenders	Page 9



HGV Bumpers

Pages 10-15

Rubber Stoppers	Page 11
Conical Bumpers	Page 11
Buffer Stops	Page 12
Oval Rubber Bump Stops	Page 12
D-Type Bumper	Page 12
Rectangular Rubber Buffer	Page 13
Heavy Duty Mud Flaps	Page 14
Tipper Pads	Page 15



Dock Bumpers

Pages 16-30

Trapezium Dock Bumpers	Page 18
UHMWP Dock Bumpers	Page 19
TPX Rectangular Dock Bumpers	Page 19
Square Dock Bumpers	Page 20
L-Shaped Dock Bumpers	Page 20
High Top Dock Bumpers	Page 20
3 Part Dock Bumper Set	Page 21
Slimline Dock Bumpers	Page 21
Steel Heavy Duty Dock Bumpers	Page 22
Laminate Dock Bumpers	Page 23
Dock Bumper Front Plates	Page 24
Dock Bumper Packer Plates	Page 26
Dock Bumper Back Plates	Page 27
Spring Loaded Back Plates	Page 29
Dock Bumper Angle Brackets	Page 30

Material Compound Key

- NR/SBR: Styrene-Butadiene and Natural Rubber**
 This is a standard blend suitable for most commercial applications.
- TPX: Tyre Cord Hi-Fibre**
 A non-vulcanised tyre compound with nylon or rayon reinforcing fibres.
- TPE: Thermoplastic Elastomer**
 A mixture of rubber and plastic which is made up from recycled materials.
- UHMWP: Ultra High Molecular Weight Polyethylene**
 A very durable bright yellow material with a low coefficient of friction.



D-Fenders and Boat Protection

Protect vehicles on land and at sea with D-fenders you can depend on.

Get peace of mind, and safely protect your vessel against both structural and aesthetic damage, with our complete range of standard rubber, PVC and TPE D-Fenders. All of our Fenders are specifically designed to absorb the force of heavy impacts, whilst reducing the risk of direct contact between the boat and the jetty or quayside. Please note – All of our B and D-Fenders are not pre-drilled as standard, but we do provide a cutting and drilling service if required.

In this section you'll discover our complete collection of:

- Standard Rubber D-Fenders
- PVC B and D-Fenders
- TPE D-Fenders

Fender Fitting Instructions

New to installing D-Fenders? Don't worry, whilst every boat and yacht is different there are some standard fitting recommendations to help you get the best results for your fender. Please visit our website and read our detailed step by step installation guide.

Tools You Will Need

- Tape Measure
- Reversible Speed Drill
- Putty Knife
- Sealant Application Gun
- Drill Bits

Materials

- D-Fender
- Rigid PVC Fixing Strips
- Marine Grade Adhesive
- Stainless Steel Screws / Bolts
- Safety Goggles

Measuring

Take time to plan the fitting of your boat and be aware of any bends or joins required.

How to calculate the length of fender you require

Double the boat's length, add the boat's width, then add an extra 1 or 2 meters to allow for the hull's radius.

Fixing Recommendations

Inserting PVC strips will help secure the fender and act as a washer for the bolts. It is recommended the fixings are between 75mm- 200mm apart, or closer for larger profiles. Be careful when drilling the fendering- if you drill too far into the boat you risk damaging the surface of the fendering with the chuck of the drill.

Tip: apply some sealant to the end of each screw before fitting to ensure the hole is well sealed!

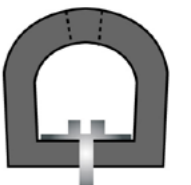
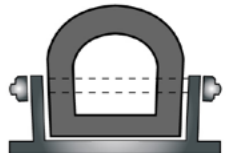
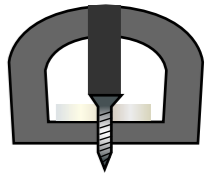

PVC Fender Fixing Strips

PVC strips are available to be fitted into the B or D-fender prior to installation to provide additional strength. They also prevent the fixings from pulling through the fender under pressure.



Product SKU	Length (mm)	Size (mm)
6009727	1000	13W x 3H
6009729	1000	19W x 3H
6009730	1000	31W x 3H
6009731	1000	38W x 6H
6009728	1000	50W x 6H

Fender Article Number	Size of Strip Required (mm)
6009699 6009700 6009701 6009709 6009710 6009711 6009714 6009715	13W x 3H
6009724 6009726 6009694 6009695 6009696 6009697 6009698 6009704 6009705 6009706 6009707 6009708	31W x 3H
6009720 6009722	38W x 6H
6009702 6009703 6009712 6009713	50W x 6H
6009716 6009717	19W x 3H

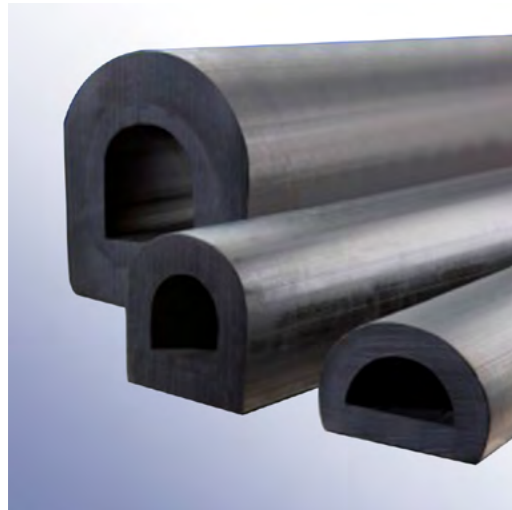

Standard Rubber D-Fenders

SPECIFICATIONS

- Material: NR/SBR Rubber
- Hardness: 80 ShA
- Density: 1.9 g/cm³
- Temperature Resistance: -20°C to 70°C

PRODUCT OVERVIEW

Our Standard D-Fenders are the economical way to protect land and sea-faring vehicles from damage and unwanted contact. Commonly used on boats, quays, warehouses and loading bays, our Standard D-Fenders will suit almost any internal or external application. Available in a wide variety of stock sizes, we are also able to supply custom variation D-Fenders upon request.

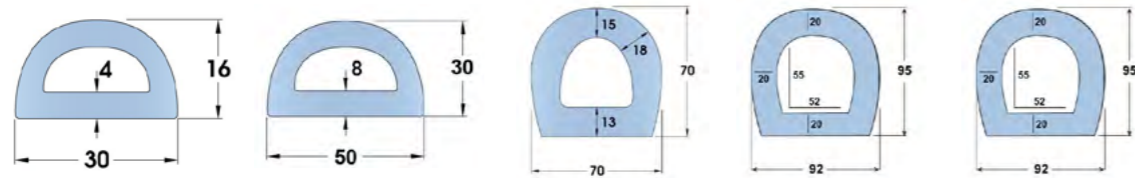

Product SKU	6001106	6001105	6001100	6001246	6010928
Length (mm)	12500	2500	2440	1000	3000

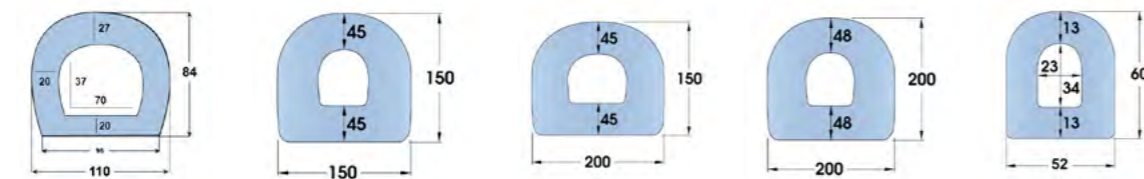

Product SKU	6010927	6001108	6001109	6001111	6001104
Length (mm)	2500	2000	2000	2000	2500

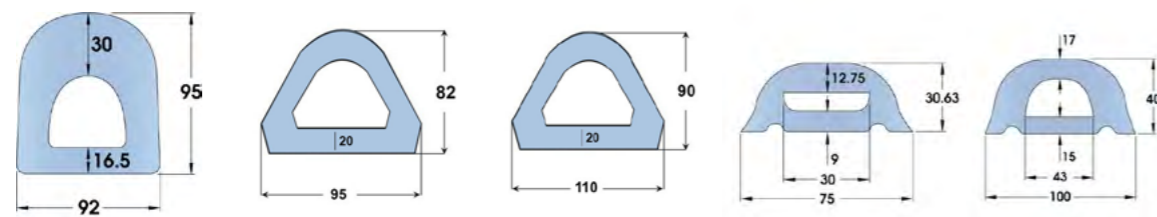

Product SKU	6001103	6001114	6001102	6001113	6001112
Length (mm)	2000	3000	3000	3000	3000

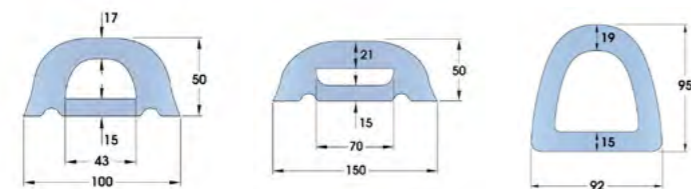

Product SKU	6005300	6001107	6001101
Length (mm)	3000	3000	2440

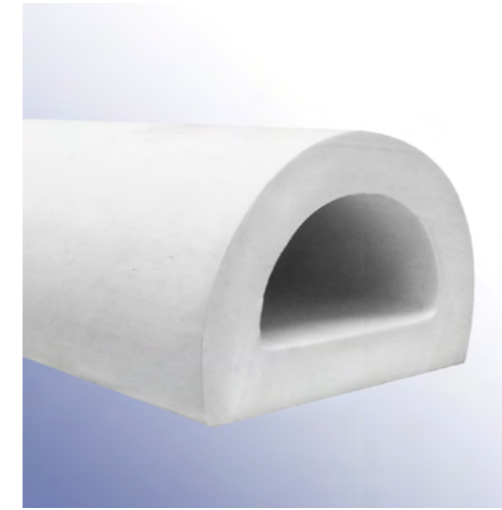

White PVC D-Fenders

SPECIFICATIONS

- Material: PVC
- Hardness: 80 ShA
- Density: 1.9 g/cm³
- Temperature Resistance: -20°C to 70°C

PRODUCT OVERVIEW

Our range of PVC D-Fenders offer a superior finish in comparison to our standard rubber D-Fenders. Additionally, PVC won't mark or scuff surfaces it comes into contact with, making them the ideal solution for rub rails along boats and yachts. All our PVC D-Fenders are UV stabilised, phthalate free and 100% recyclable.

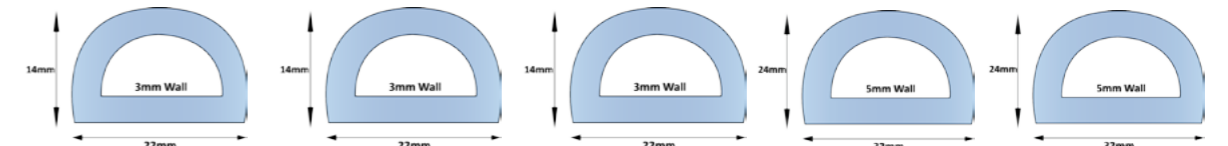

Product SKU	6009699	6009700	6009701	6001150	6009718
Length (mm)	9000	15000	30000	3000	9000

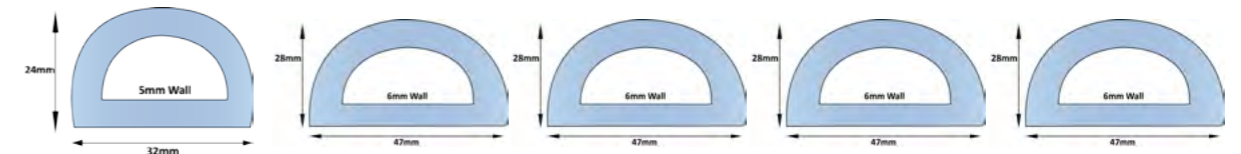

Product SKU	6010796	6009694	6009695	6009696	6009697
Length (mm)	15000	5000	10000	15000	20000

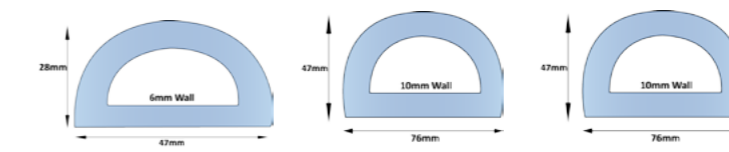

Product SKU	6009698	6009702	6009703
Length (mm)	30000	3000	6000

PVC Fender Fixing Strips

PVC strips are available to be fitted into the B or D-fender prior to installation to provide additional strength. They also prevent the fixings from pulling through the fender under pressure.



Product SKU	Length (mm)	Size (mm)
6009727	1000	13W x 3H
6009729	1000	19W x 3H
6009730	1000	31W x 3H
6009731	1000	38W x 6H
6009728	1000	50W x 6H

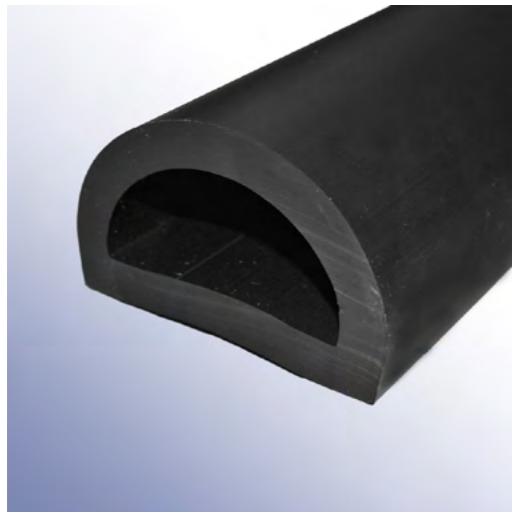

Black PVC D-Fenders

SPECIFICATIONS

- Material: PVC
- Hardness: 80 ShA
- Density: 1.9 g/cm³
- Temperature Resistance: -20°C to 70°C

PRODUCT OVERVIEW

Our range of PVC D-Fenders offer a superior finish in comparison to our standard rubber D-Fenders. Additionally, PVC won't mark or scuff surfaces it comes into contact with, making them the ideal solution for rub rails along boats and yachts. All our PVC D-Fenders are UV stabilised, phthalate free and 100% recyclable.

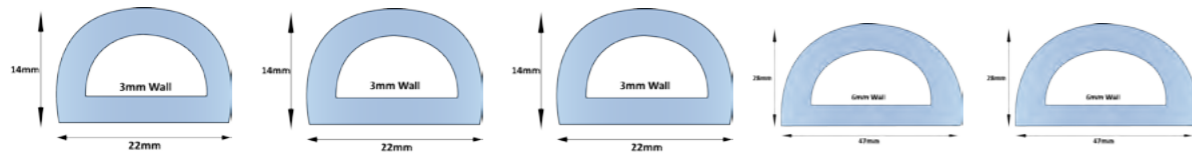

Product SKU	6009709	6009710	6009711	6009704	6009705
Length (mm)	9000	15000	30000	5000	10000

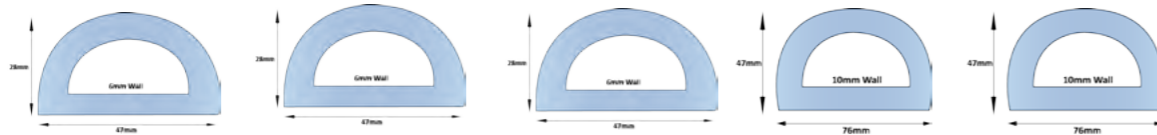

Product SKU	6009706	6009707	6009708	6009712	6009713
Length (mm)	15000	20000	30000	3000	6000

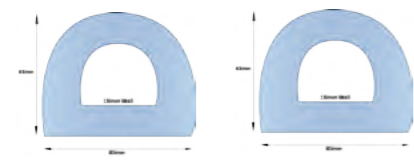

Product SKU	6009720	6009722
Length (mm)	3000	9000

PVC Fender Fixing Strips

PVC strips are available to be fitted into the B or D-fender prior to installation to provide additional strength. They also prevent the fixings from pulling through the fender under pressure.



Product SKU	Length (mm)	Size (mm)
6009727	1000	13 x 3
6009729	1000	19 x 3
6009730	1000	31 x 3
6009731	1000	38 x 6
6009728	1000	50 x 6

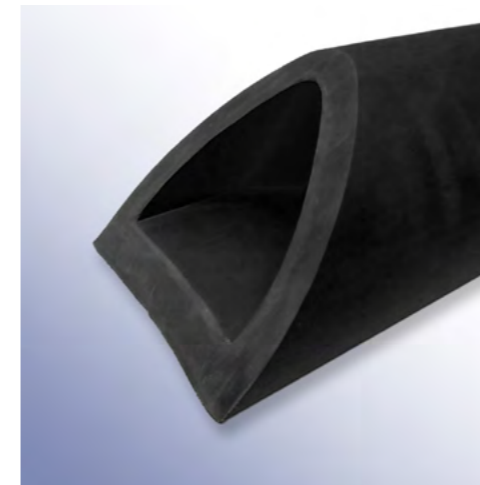

TPE D-Fenders

SPECIFICATIONS

- Material: TPE (Thermoplastic Elastomer)
- Hardness: 60 ShA
- Density: 1.09 g/cm³
- Elongation at Break: 700%
- Temperature Resistance: -40°C to 100°C

PRODUCT OVERVIEW

Our TPE D-Fenders are made with a specialised material for ultimate resistance to weathering, aging, UV, atmospheric agents and chemicals. Unlike our standard rubber D-Fenders, TPE is non-marking and supremely weather-resistant, giving your vessel the best protection without staining or deteriorating. All our TPE D-Fenders are made from recycled materials and are 100% recyclable after use.

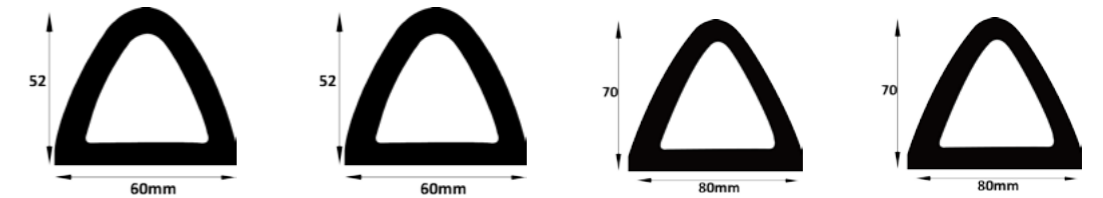

Product SKU	1055152	1055153	1055155	1055156
Length (mm)	5000	5000	5000	5000
Colour	Black	Grey	Black	Grey

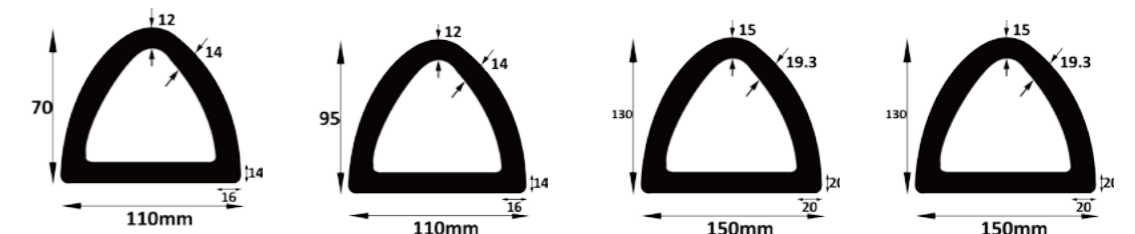

Product SKU	1055158	1055159	1055161	1055162
Length (mm)	5000	5000	5000	5000
Colour	Black	Grey	Black	Grey

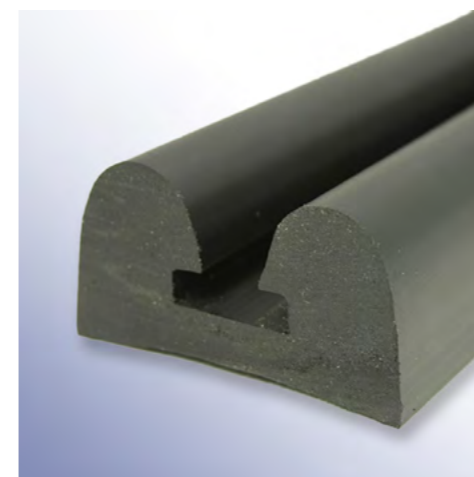

Black PVC B-Fenders

SPECIFICATIONS

- Material: PVC
- Hardness: 80 ShA
- Density: 1.9 g/cm³
- Temperature Resistance: -20°C to 70°C

PRODUCT OVERVIEW

Our B-Fenders work just as effectively as their D-Fender counterparts with a profile that creates two contact points. PVC is non-marking to stop scuffs and staining on surfaces it comes into contact with, whilst comfortably withstanding weathering, aging and high exposure to salt. All our PVC B-Fenders are UV stabilised, phthalate free and 100% recyclable.

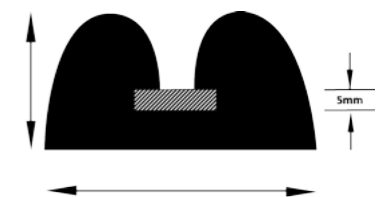

Product SKU	6009714	6009715	6009716	6009717
Length (mm)	15000L x 39W x 16H	30000L x 39W x 16H	10000 x 60W x 30H	15000L x 60W x 30H



HGV Bumper Solutions

Versatile rubber buffers for almost any application.

Whatever you need protecting, from warehouse doors to HGVs, our range of robust rubber bumpers, tipper pads and mud flaps will be up for the challenge. All of our bumper solutions are made from hardwearing NR/SBR rubber and available in a wide selection of shapes and sizes to suit almost any application.

In this section you'll discover our complete collection of:

- Rubber Stoppers and Bumpers
- Mud Flaps
- Tipper Pads



Rubber Stoppers

SPECIFICATIONS

- Material: NR/SBR Rubber
- Hardness: 70 ShA
- Density: 1.9 g/cm³
- Temperature Resistance: -15°C to 70°C

PRODUCT OVERVIEW

Our range of affordable, hardwearing Rubber Stoppers work great as spacers, door stops or as screw-on rubber feet. Made from a durable NR/SBR material, they're available in a variety of shapes and sizes to suit your application.

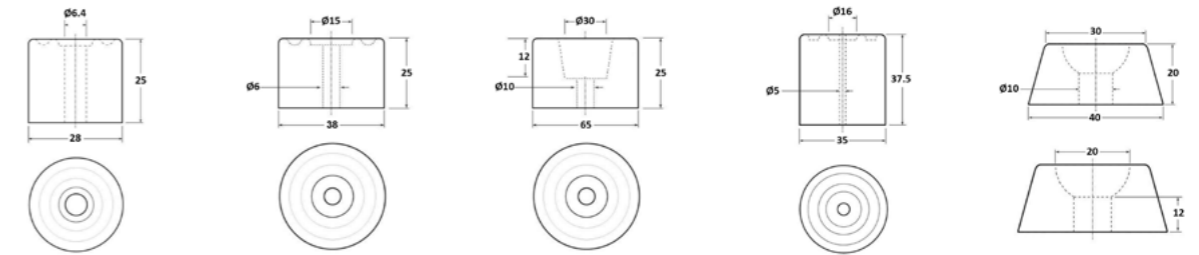

SKU	6001200	SKU	6001201	SKU	6001202	SKU	6001204	SKU	6001205
Size (mm)	28W x 25H	Size (mm)	38W x 25H	Size (mm)	65W x 25H	Size (mm)	35W x 37H	Size (mm)	40W x 20H

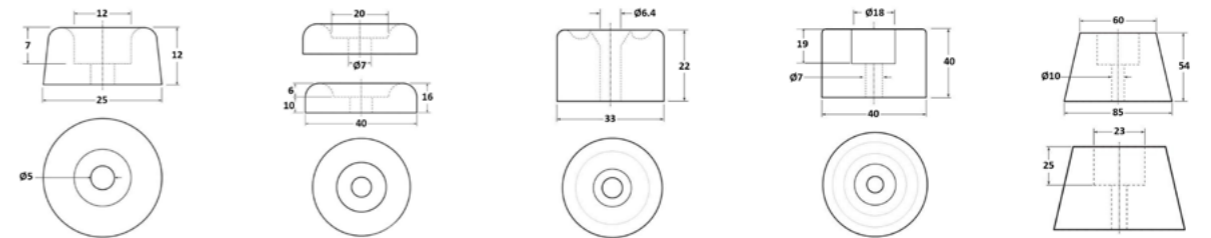

SKU	6001199	SKU	6001215	SKU	6006501	SKU	6001207	SKU	6006102
Size (mm)	25W x 12H	Size (mm)	40W x 15H	Size (mm)	33W x 22H	Size (mm)	40W x 40H	Size (mm)	85W x 54H

Conical Rubber Bumpers

SPECIFICATIONS

- Material: NR/SBR Rubber
- Hardness: 70 ShA
- Density: 1.9 g/cm³
- Temperature Resistance: -15°C to 70°C

PRODUCT OVERVIEW

Our Conical Rubber Bumpers are specially designed to provide additional height for situations that require a taller spacer or buffer. These Rubber Bumpers are made from a hardwearing blend of NR/SBR rubber and come in two sizes as standard. Each bumper has a convenient pre-drilled countersunk hole that requires an M10 fixing bolt (sold separately) in order to securely fasten to your chosen surface.

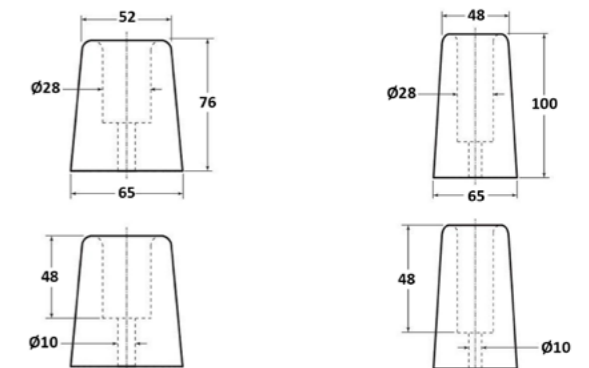

Product SKU	6006101	Product SKU	6006100
Size (mm)	65W x 76H	Size (mm)	65W x 100H

Buffer Stops

SPECIFICATIONS

- Material: NR/SBR Rubber
- Hardness: 70 ShA
- Density: 1.9 g/cm³
- Temperature Resistance: -15°C to 70°C

PRODUCT OVERVIEW

Our selection of hardwearing Buffer Stops are the perfect way to protect against harsh impacts from doors and swinging objects. Each Buffer Stop has two countersunk holes to help securely fasten to your chosen surface.

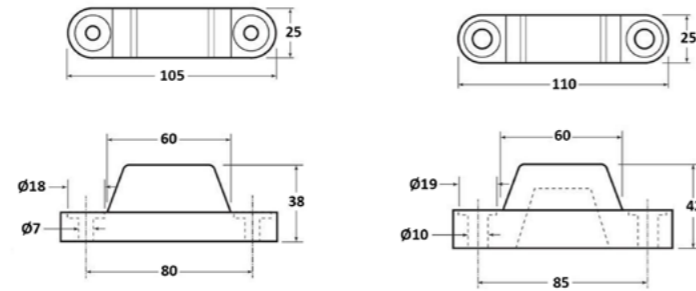

Product SKU	6001213	Product SKU	6001214
Size (mm)	105L x 25W x 38H	Size (mm)	110L x 25W x 42H

Oval Rubber Bump Stops

SPECIFICATIONS

- Material: NR/SBR Rubber
- Hardness: 70 ShA
- Density: 1.9 g/cm³
- Temperature Resistance: -15°C to 70°C

PRODUCT OVERVIEW

Our two bolt hole Oval Rubber Bump Stops are great for creating a secure buffer on lorries, vans, ramps, loading bays and doors. We offer three Bump Stops depending on your needs: A solid buffer for heavy impact, a hollow cored version to suit lighter applications and an extended base version which gives 52mm clearance.

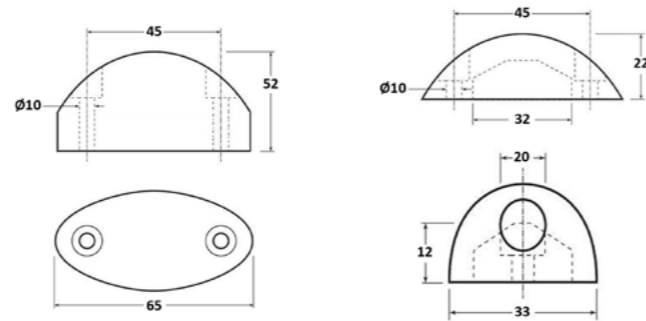

Product SKU	Size (mm)	Type
6006402	65L x 33W x 52H	Extended Base
6006401	65L x 33W x 22H	Solid Version
6006400	65L x 33W x 22H	Hollow Version

D-Type Bumpers

SPECIFICATIONS

- Material: NR/SBR Rubber
- Hardness: 70 ShA
- Density: 1.9 g/cm³
- Temperature Resistance: -15°C to 70°C

PRODUCT OVERVIEW

One of the best sellers in our bumper range, the D-Type Bumper is designed to give the greatest deflective force against heavy and repetitive impact. Made from durable NR/SBR rubber it's a simple, yet highly-effective, design to protect walls and other surfaces. The D-Type Bumper is ideal for docking bays, trucks and boats.

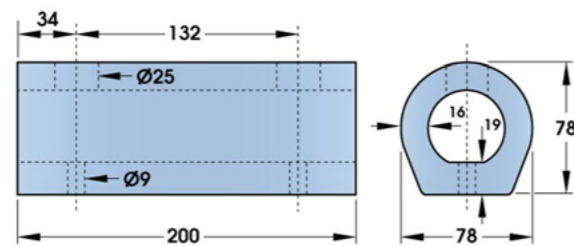

SKU	6006300
Size (mm)	200L x 78W x 78H

Rectangular Rubber Buffers

SPECIFICATIONS

- Material: NR/SBR Rubber
- Hardness: 80 ShA
- Density: 1.9 g/cm³
- Temperature Resistance: -20°C to 70°C

PRODUCT OVERVIEW

The Rectangular Rubber Buffers provide effective protection against especially harsh impacts and can be easily bolted directly to your desired surface using the pre-drilled countersunk holes. Our range of Rectangular Buffers come in an array of sizes perfect for use on lorries, vans, ramps, loading bays and doors..

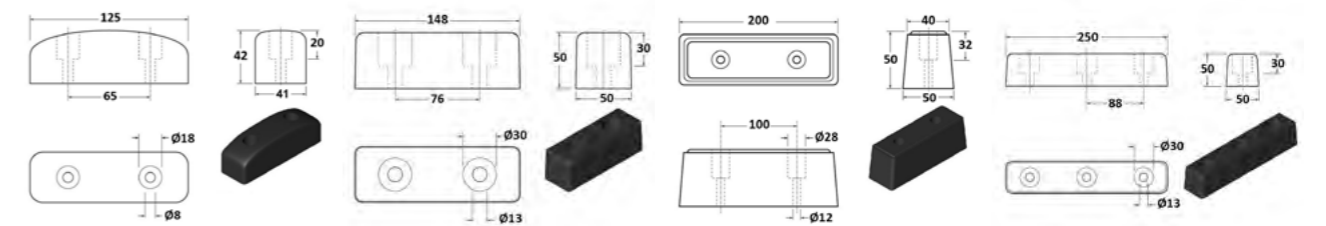

SKU	6007105	SKU	6007103	SKU	6007104	SKU	6007102
Size (mm)	127L x 41W x 43H	Size (mm)	148L x 50W x 50H	Size (mm)	200L x 50W x 50H	Size (mm)	247L x 50W x 50H

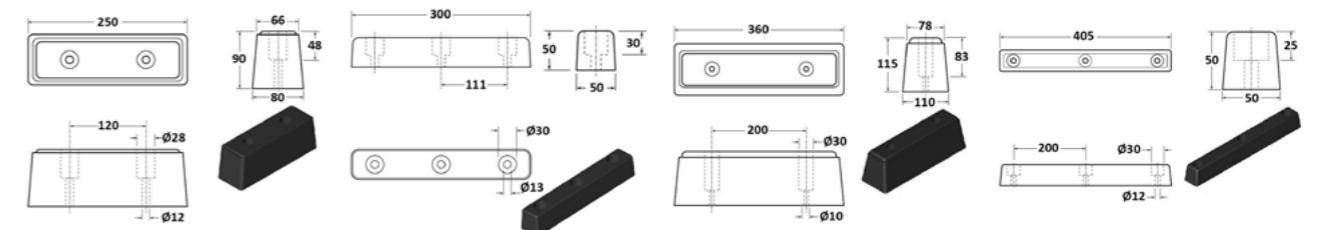

SKU	6007201	SKU	6007100	SKU	6007202	SKU	6007101
Size (mm)	250L x 80W x 90H	Size (mm)	302L x 50W x 50H	Size (mm)	360L x 110W x 115H	Size (mm)	405L x 50W x 50H

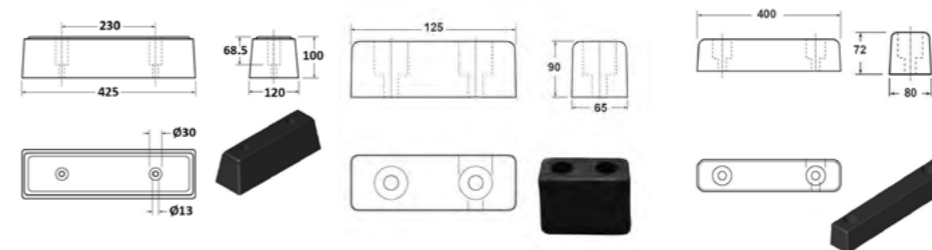

SKU	6007203	SKU	6007200	SKU	6010922
Size (mm)	425L x 120W x 100H	Size (mm)	125L x 65W x 90H	Size (mm)	400L x 80W x 72H

Heavy Duty Mud Flaps

SPECIFICATIONS

- Material: TPX
- Hardness: 78 Sha
- Tensile Strength: 3.4 MPa
- Thickness: 6mm
- Temperature Resistance:-20°C to 70°C

PRODUCT OVERVIEW

Choose from over 30 universal, heavy duty, Mud Flaps suitable for HGVs, trucks, trailers, lorries and cars. These commercial Mud Flaps are made from TPX Tyre Cord Hi-Fibre which is fabricated using compound nylon/rayon reinforcing fibres for extra protection. The entire collection of Mud Flaps can be screen printed with a graphic design of your choice.

*For more information about our custom printing service please speak with a member of our sales team on +44 (0)1420 474123 or sales@polymax.co.uk.



Product SKU	Width (mm)	Height (mm)	*Print Width (mm)	*Print Height (mm)
6001240	2438	381	2328	251
6010893	2390	305	2315	220
6001236	610	305	510	175
6001237	610	406	510	256
6001238	610	457	510	307
6001239	610	914	510	181
6001232	559	305	458	180
6001233	559	406	458	256
6001234	559	457	458	307
6001235	559	914	470	181
6001229	533	305	433	180
6001230	533	406	433	256
6001231	533	457	433	307
6001226	508	305	408	180
6001227	508	406	408	256
6010894	508	457	408	307
6010895	500	250	350	115
6001224	457	305	357	180
6001225	457	406	357	281
6001223	406	305	305	180
6001222	381	457	281	307
6001221	347	305	255	180
6001220	305	305	205	180
6010896	305	406	280	300
6001219	254	254	154	129
6001218	229	305	128	178
6010897	150	250	100	100

Tipper Pads for Tipper Lorries

PRODUCT OVERVIEW

Tipper Pads are used to protect the chassis of tipper lorries. They are designed to withstand heavy and repetitive loads, protecting the bodywork of the vehicle whilst dampening the sound of the impact. Our Tipper Pads are made using a thick block of rubber, which is bonded to either an aluminium or steel base for additional protection. They can be fitted to the vehicle with bolts or welded directly to the metal work. There are three types of base to choose from: Aluminium, traditional steel or a black-painted anti-rust steel.



Product SKU DM8419M6-2	Size (mm) 84L x 32W x 19H	Bolt Holes 2 x M6	Product SKU DM15240-3	Size (mm) 152L x 40W x 30H	Bolt Holes None
Rubber: 46L x 25W x 17H Steel: 84L x 32W x 3H		Rubber: 100L x 40W x 25H Steel: 150L x 40W x 5H		Rubber: 92L x 62W x 35H Steel: 153L x 62W x 5H	
Product SKU DM18034-3	Size (mm) 180L x 75W x 34H	Bolt Holes 2 x M8	Product SKU DM18045M8-3	Size (mm) 180L x 75W x 46H	Bolt Holes 2 x M8
Rubber: 115L x 75W x 29H Aluminium: 180L x 75W x 5H		Rubber: 115L x 75W x 46H Aluminium: 180L x 75W x 4H		Rubber: 290L x 75W x 39H Aluminium: 355L x 75W x 5H	
Product SKU DM35575-3	Size (mm) 355L x 75W x 30H	Bolt Holes None	Product SKU DM18050-3	Size (mm) 180L x 75W x 45H	Bolt Holes 4 x M8
Rubber: 290L x 74W x 27H Steel: 355L x 75W x 3H		Rubber: 115L x 75W x 40H Aluminium: 180L x 75W x 5H		Rubber: 100L x 86W x 22H Steel: 152L x 88W x 6H	
Product SKU DM15288-3	Size (mm) 152L x 88W x 28H	Bolt Holes None	Product SKU DM15275-3	Size (mm) 152L x 88W x 43H	Bolt Holes None
Rubber: 100L x 86W x 23H Aluminium: 152L x 88W x 5H		Rubber: 100L x 88W x 38H Aluminium: 152L x 88W x 5H		Rubber: 120L x 112W x 14-20H Aluminium: 190L x 115W x 6H	



Loading Bay Solutions

Complete loading bay protection from every vehicle, every time.

Our comprehensive collection of Dock Bumpers are designed to prevent damage from vehicles reversing into loading bay areas and marinas. Suitable for any industrial building, warehouse or commercial loading area, we can provide everything from large, stainless steel wall or dock-mounted bumpers, to small and sturdy rubber Bumpers that can be attached directly to the vehicle.

In this section you'll discover our complete collection of:

- Dock Bumpers
- Angle Brackets
- Front, Packer and Back Plates

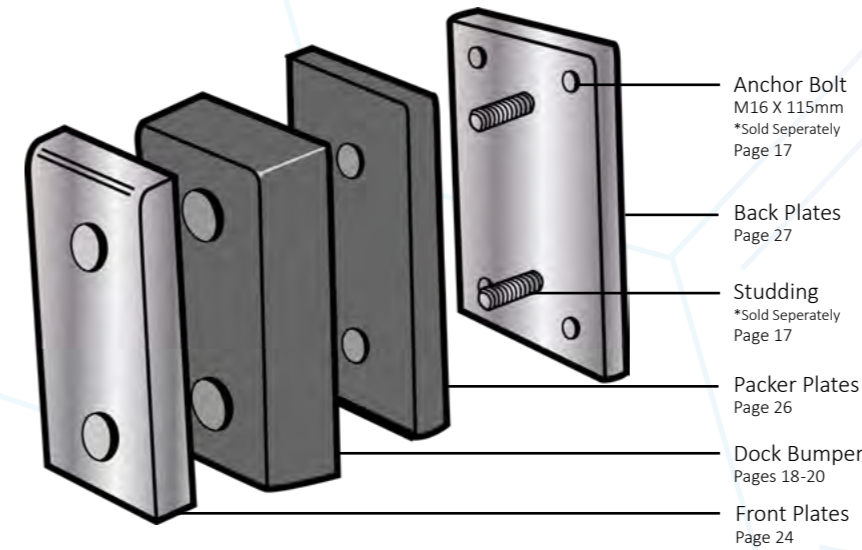

Dock Bumper Parts

Front Plate – A stainless-steel front plate to prevent wear to the rubber component whilst still allowing for the same level of compression.

Packer Plate – An extra layer of rubber that enhances the dock bumper to suit the desired dimension. Please note, some packers require holes to be drilled.

Back Plate – Whilst the rubber bumpers can be fixed directly to the wall or dock leveller, we highly recommend using a metal backing plate. This improves the structural integrity of the buffer and makes it easy to replace if necessary.

Please Note- hanging the dock bumpers to the corresponding plates will require M24 studding which is also available to purchase on our site.

Dock Bumper	Front	Packer	Back
6004102	6009623	No compatible packer plate	6003200, 6010907, 6010915
6004100, 6004101	6009101	6010899, 6010900, 6010901, 6010902	6003200, 6010907, 6010915
6004200, 6004203	6009103	6010906, 6010904, 6010905	6003202, 6010919, 6010916
6004300, 6010885	6009624	6010903	No compatible back plate
6009406	6009627	No compatible packer plate	6010913
6009408	6009628	No compatible packer plate	6010914
6009400	6010891	No compatible packer plate	6010917, 6010915
6009401	6010892	No compatible packer plate	6010918, 6010916
6010888, 6010887	6009622, 6009621	No compatible packer plate	6010908
6009610	6009622, 6009621	6010899, 6010900, 6010901, 6010902	6010909
6009611	6009622, 6009621	6010899, 6010900, 6010901, 6010902	6010910
6009612	6009625, 6010890	6010904, 6010905, 6010906	6010911
6009613	6009625, 6010890	6010904, 6010905, 6010906	6010912



SKU **6001252**
Size (mm) M16 x 115L



SKU **4000113**
Size (mm) 24D x 5H



SKU **4000114**
Size (mm) 24D x 1H

M24 Studding

The length required depends on the number of Packer Plates and Front Plates used with your configuration. Contact a member of our friendly sales team if you have any questions.

6001260	M24 X 90mm
6001261	M24 X 100mm
6001262	M24 X 120mm
6001263	M24 X 150mm
6001264	M24 X 300mm



Trapezium Dock Bumpers

SPECIFICATIONS

- Material: NR/SBR Rubber or TPX
- Temperature Resistance: -20°C to 70°C

PRODUCT OVERVIEW

Our durable, weather-resistant Trapezium Dock Bumpers come in a range of industry-standard sizes that can be attached along the main contact points of the dock leveller or loading bay. Available in a trapezium design or with a straight edge, these Dock Bumpers are perfectly suited to both on-land and marine applications. Choose between the standard NR/SBR rubber or the more resilient Tyre Cord Hi-Fibre TPX rubber, ideal for high-traffic areas and larger vehicles.

Please note - 330mm Bumpers have no matching front or back plates.

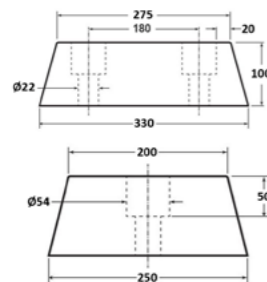

Product SKU	Size (mm)	Weight (kg)
6009405	330L x 250W x 100H	7.2

Material : NR/SBR

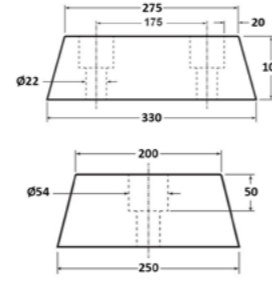

Product SKU	Size (mm)	Weight (kg)
6010884	330L x 250W x 100H	6.15

Material : Tyrecord Hi-Fibre

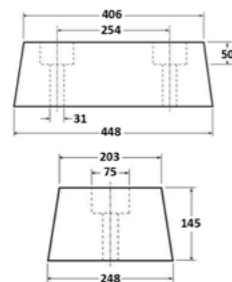

Product SKU	Size (mm)	Weight (kg)
6004102	448L x 248W x 145H	16

Material : NR/SBR

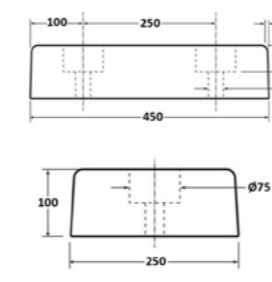

Product SKU	Material	Size (mm)	Weight (kg)
6004100	NR/SBR	450L x 250W x 100H	13.5
6004101	TPX		11.0

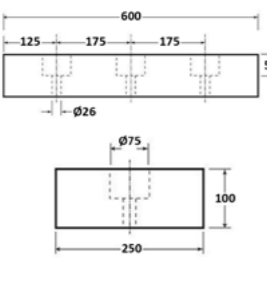

Product SKU	Material	Size (mm)	Weight (kg)
6004201	NR/SBR	600L x 250W x 100H	14
6004204	TPX		17

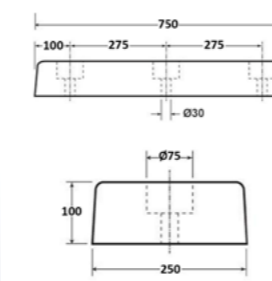

Product SKU	Material	Size (mm)	Weight (kg)
6004200	NR/SBR	750L x 250W x 100H	18
6004203	TPX		17

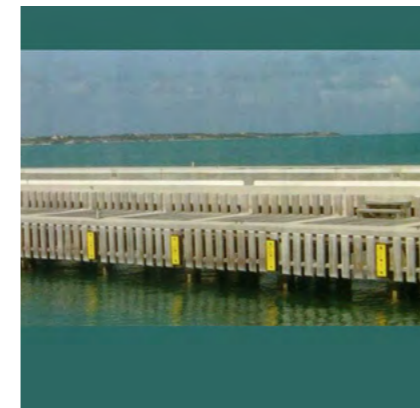

High Visibility UHMWP Dock Bumpers

PRODUCT OVERVIEW

These long-lasting, high-visibility Dock Bumpers help drivers easily line up their vehicles with the dock. They are made from a high molecular weight polyethylene material to increase durability in high-impact, hardwearing environments. The smooth front plates are also designed to dramatically reduce friction and help prevent scraping and marking of vehicles. Both the front and back plate can be easily replaced if they become damaged or worn.

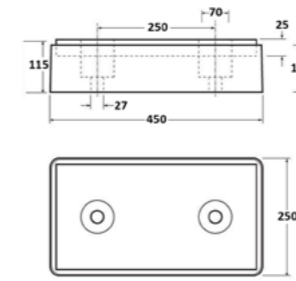

Product SKU	Size (mm)	Weight (kg)
6009400	450L x 250W x 115H	12.5

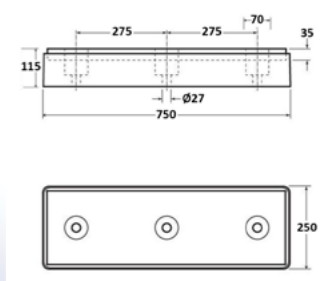

Product SKU	Size (mm)	Weight (kg)
6009401	750L x 250W x 115H	21.5



TPX Rectangular Dock Bumpers

SPECIFICATIONS

- Material: TPX
- Hardness: 80 ShA
- Tensile Strength: 3.4
- Temperature Resistance: -15°C to 70°C

PRODUCT OVERVIEW

These strong TPX Rubber Dock Bumpers are ideal for lining protruding metalwork on HGV trailers to help prevent damage. They can also be used in pairs to line the side of vans, ramps, loading bays and doors, to further protect against heavy impacts. We offer two lengths, with either three or six bolt holes.

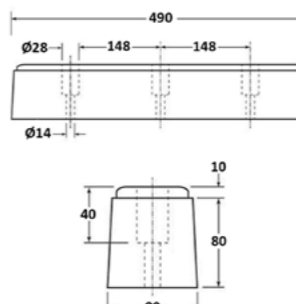

Product SKU	Size (mm)	Weight (kg)
6009403	490L x 80W x 90H	3.2

Material : Tyrecord Hi-Fibre

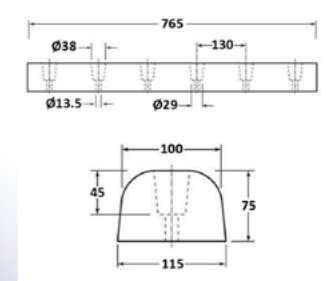

Product SKU	Size (mm)	Weight (kg)
6010886	750L x 115W x 75H	6.5

Material : Tyrecord Hi-Fibre

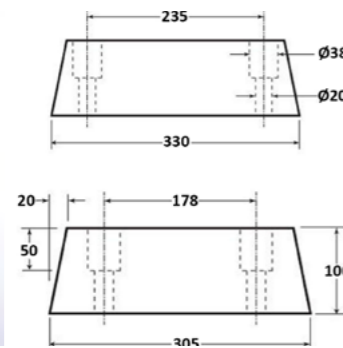

Square Dock Bumpers

SPECIFICATIONS

- Material: TPX
- Hardness: 80 ShA
- Tensile Strength: 3.4
- Temperature Resistance: -15°C to 70°C

PRODUCT OVERVIEW

This small square-shaped Dock Bumper has a unique 4-bolt hole design, perfect for protecting steelwork around loading docks. Although small in size, this little bumper is made from our Type Cord Hi-Fibre rubber, making it capable of withstanding an impressive amount of force.

Please note - This has no compatible back or front plate.

Product SKU	Size (mm)	Weight (kg)
6007106	330L x 305W x 100H	8.5
Material : TyreCORD Hi-Fibre		

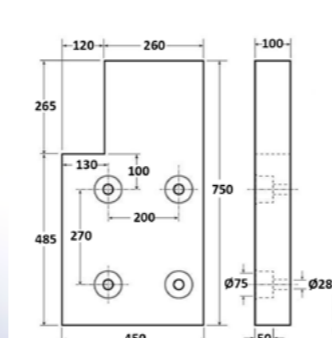
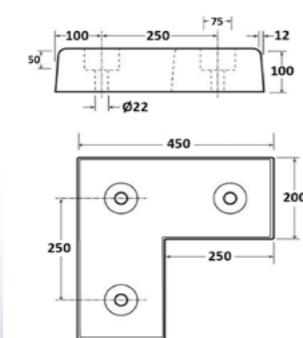

Product SKU	Type	Size (mm)	Weight (kg)
6009406	Left	750L x 400W x 100H	35
6009408	Right		
Material : NR/SBR			

Product SKU	Material	Size (mm)	Weight (kg)
6004300	NR/SBR	450L x 450W x 100H	12
6010885	TPX		

L-Shaped Dock Bumpers

DETAILS

Our L-Shaped Dock Bumpers provide sturdy corner protection along the tops of loading bays or dock levellers.

High Top Dock Bumpers

DETAILS

Our High Top Dock Bumpers are designed to offer the best protection for the top of the dock leveller.

Dock Bumper Angle Brackets

DETAILS

Our sturdy, galvanised steel, Dock Bumper Angle Brackets allow standard back plates and dock bumper assemblies to be securely fixed up to 150mm above the dock. They come in two sizes, each finished in your choice of high-visibility red or yellow powder coated paint, to suit your corresponding dock bumper and back plate as required.

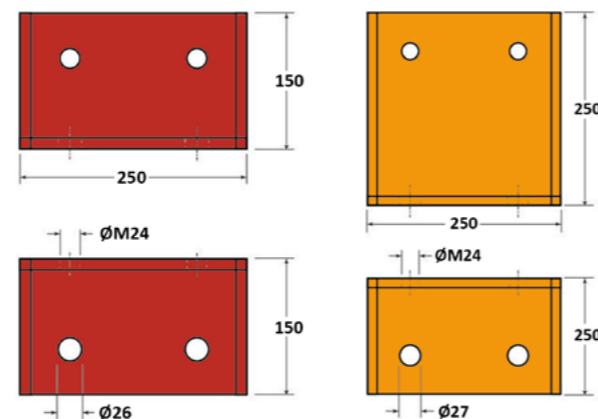
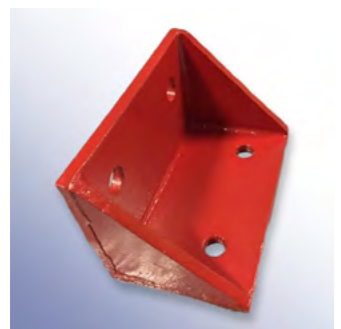

Product SKU	Size (mm)	Product SKU	Size (mm)
4000013	250L x 150W x 150H	4000014	250L x 250W x 150H
Weight (kg): 8.1		Weight (kg): 12	



Three Part Dock Bumper Set

SPECIFICATIONS

- Material: UHMWP
- Temperature Resistance: -20°C to 70°C

PRODUCT OVERVIEW

This complete Three Part Dock Bumper Set is comprised of a back plate, packer and front plate. The front plate and packer plate are designed to easily slide out for quick removal or replacement. This set is one of our best solutions for preventing damage in particularly high traffic loading bays and jetties. Available in two different lengths and depths.

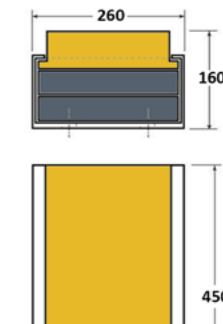
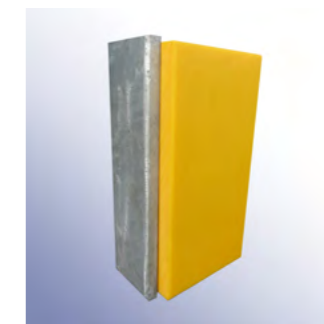
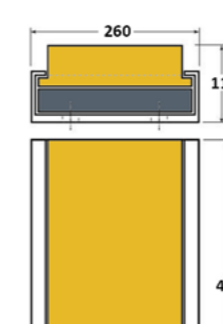

Product SKU	Size (mm)	Weight (kg)
6009610	450L x 260W x 110H	27

Product SKU	Size (mm)	Weight (kg)
6009611	450L x 260W x 160H	37.5

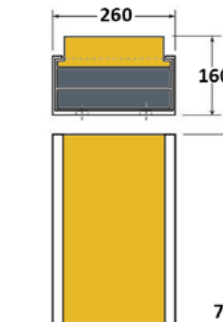
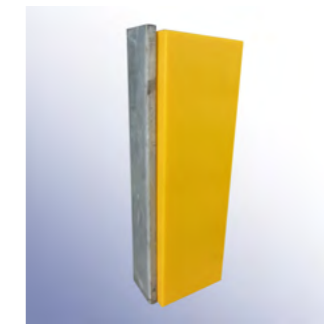
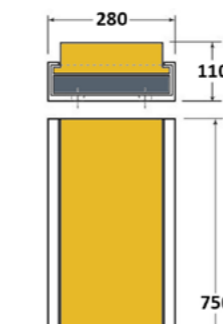
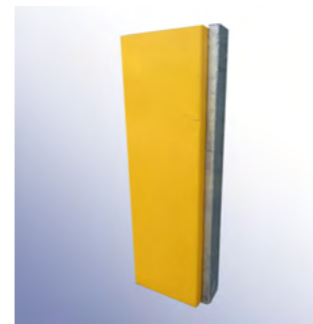

Product SKU	Size (mm)	Weight (kg)
6009612	750L x 260W x 115H	45

Product SKU	Size (mm)	Weight (kg)
6009613	750L x 260W x 160H	63



Slimline Dock Bumpers

SPECIFICATIONS

- Material: UHMWP
- Temperature Resistance: -20°C to 70°C

PRODUCT OVERVIEW

This set is comprised of a back plate, and a more slimline 60mm front plate that can slide out for easy removal or replacement. It is the perfect choice for when you need vehicles to reverse closer to the loading bay or jetty. Choose between a durable NR/SBR rubber front plate, or a high-visibility, low-friction, polyethylene front plate ideal for high-traffic areas.

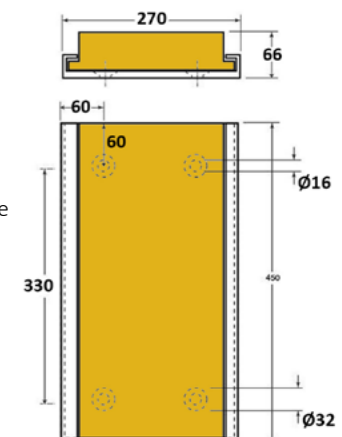

Product SKU	Size (mm)	Weight (kg)
SBR: 6010887 UHP: 6010888	450L x 270W x 60H	17.5

Steel Heavy Duty Dock Bumpers

PRODUCT OVERVIEW

Our toughest Dock Bumpers in the range offer the highest level of protection against HGV trailers. This collection of tough, stainless-steel, dock bumpers perform under extreme forces; with a unique steel-encased rubber core that allows for the full absorption of force, whilst the stainless-steel body prevents wear and tear. The sloped top helps prevent trailers from overriding the dock leveller or loading bay.

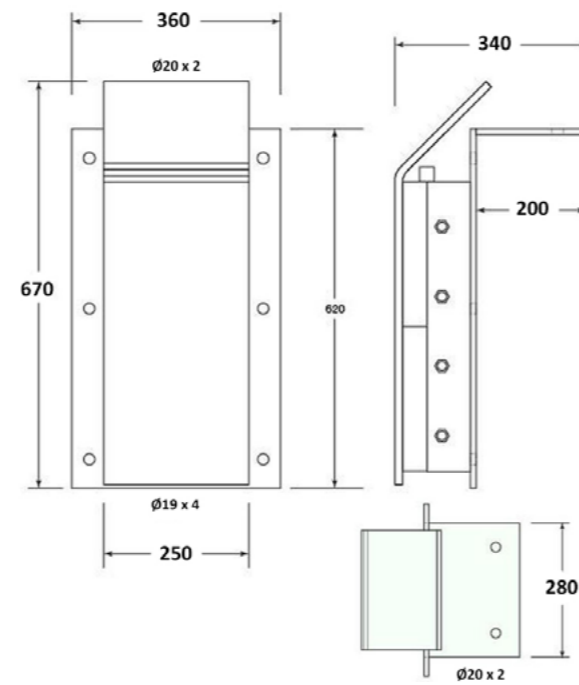

Product SKU	Size (mm)
6009617	670L x 360W x 340H
Weight (kg): 65	

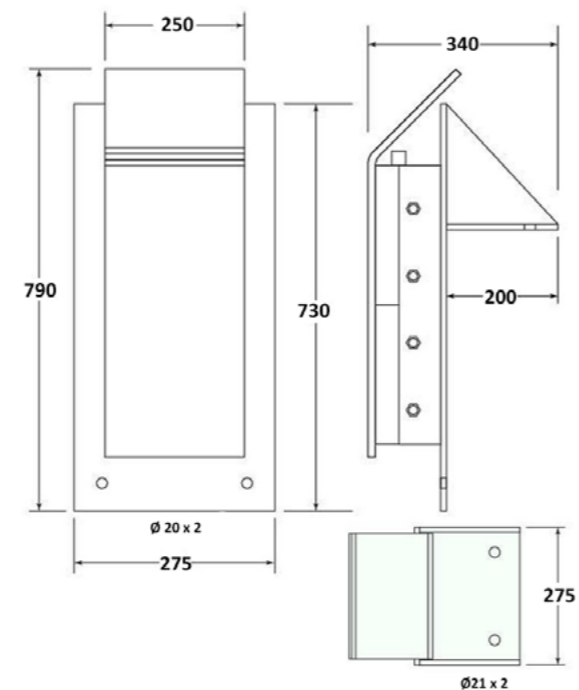

Product SKU	Size (mm)
6009618	790L x 275W x 340H
Weight (kg): 67	

Products continued on next page...

... Heavy Duty Steel Dock Bumpers continued.

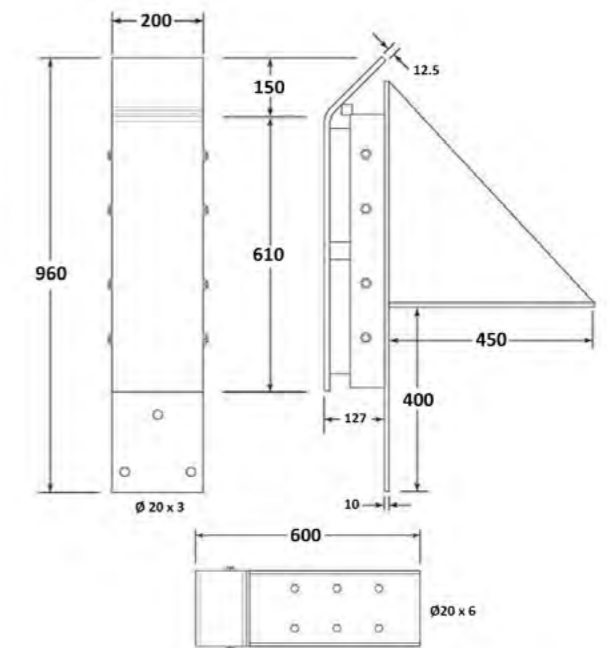

Product SKU	Size (mm)
6010889	900L x 200W x 600H
Weight (kg): 67	

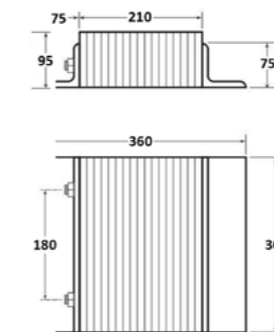

Laminate Dock Bumpers

SPECIFICATIONS

- Material: NR/SBR Rubber
- Temperature Resistance: -20°C to 70°C

PRODUCT OVERVIEW

Our Laminate Dock Bumpers are the strongest standalone rubber bumpers in the range. Made from compressed conveyor belt rubber for excellent endurance and added durability, it is proven to be one of the most effective ways to protect loading bays from repeated heavy impacts, no matter the vehicle.

Product SKU	Size (mm)	Weight (kg)
6009614	300L x 250W x 100H	15
Material : NR/SBR		

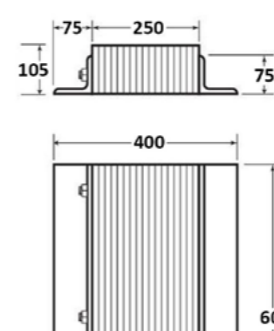

Product SKU	Size (mm)	Weight (kg)
6009615	600L x 250W x 100H	28
Material : NR/SBR		

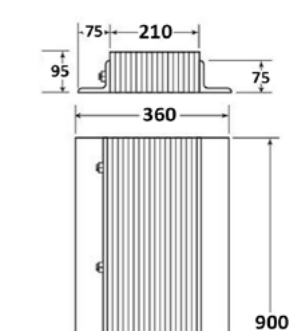

Product SKU	Size (mm)	Weight (kg)
6009616	900L x 250W x 100H	41
Material : NR/SBR		

Dock Bumper Front Plates

SPECIFICATIONS

- View all corresponding dock bumper parts on page 17

PRODUCT OVERVIEW

We offer a full range of Front Plates to suit any sized Dock Bumper. Attaching a Front Plate to the Dock Bumper significantly increases its durability and performance over time. The metal remains undamaged whilst the rubber Dock Bumper compresses behind the added protection of the Front Plate.

Please note - The Three Part Set, High-Visibility and Slimline Dock Bumpers are sold with a front plate included. Attaching the Dock Bumpers to the Front Plate will require M24 studding, see page 34.

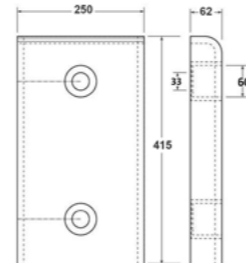
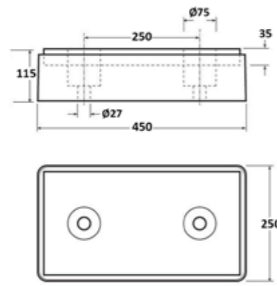

Product SKU	Size (mm)	Weight (kg)
6010891	410L x 210W x 35H	2.5
Material : UHMWP		

Product SKU	Size (mm)	Weight (kg)
6009623	415L x 250W x 62H	14
Material : Steel		

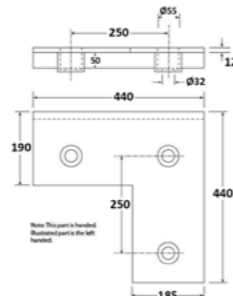
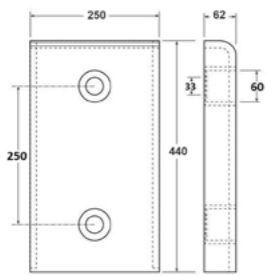

Product SKU	Size (mm)	Weight (kg)
6009101	440L x 250W x 62H	16
Material : Steel		

Product SKU	Size (mm)	Weight (kg)
6009624	440L x 440W x 62H	13.5
Material : Steel		

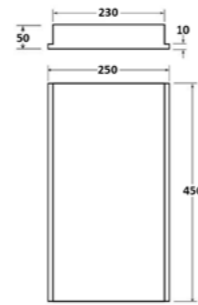
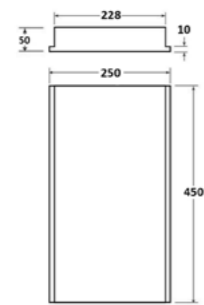
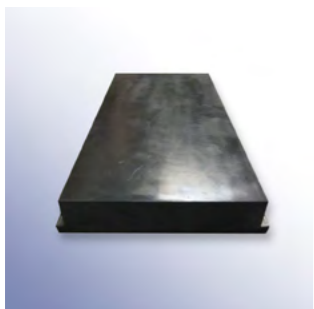

Product SKU	Size (mm)	Weight (kg)
6009622	448L x 248W x 50H	7
Material : NR/SBR		

Product SKU	Size (mm)	Weight (kg)
6009621	450L x 250W x 50H	5
Material : UHMWP		

Products continued on next page...

... Dock Bumper Front Plates continued.

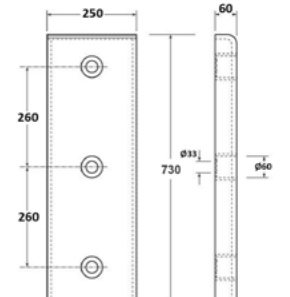
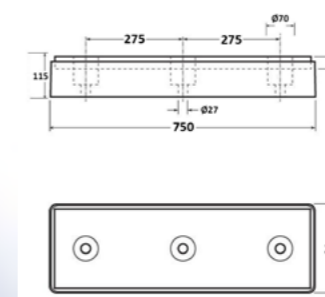

Product SKU	Size (mm)	Weight (kg)
6010892	750L x 250W x 35H	4.5
Material : UHMWP		

Product SKU	Size (mm)	Weight (kg)
6009103	732L x 250W x 62H	26
Material : Steel		

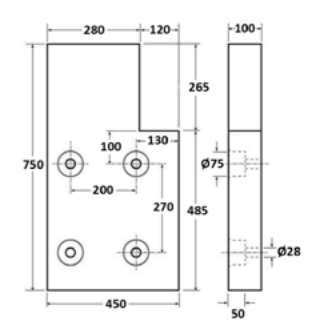

Product SKU	Size (mm)	Weight (kg)
6009625	750L x 250W x 50H	8
Material : UHMWP		

Product SKU	Size (mm)	Weight (kg)
6009627	750L x 450W x 100H	36
Material : Steel		

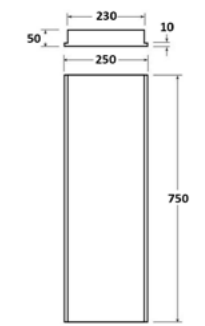
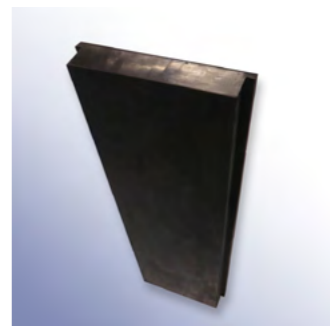
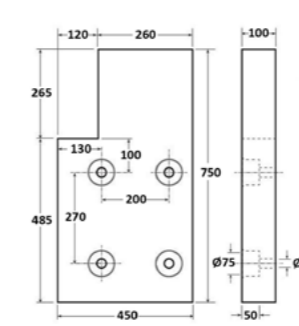

Product SKU	Size (mm)	Weight (kg)
6009628	750L x 450W x 100H	36
Material : Steel		

Product SKU	Size (mm)	Weight (kg)
6010890	750L x 250W x 50H	12
Material : NR		

Dock Bumper Packer Plates

SPECIFICATIONS

- View all corresponding dock bumper parts on page 17.

PRODUCT OVERVIEW

Packer Plates are designed to improve compression resistance. Adding an extra layer of rubber increases the durability and lifespan of the Dock Bumper.

Please note - The Three Part Set and Slimline Dock Bumpers are sold with the packing plate included. Attaching the Dock Bumpers to the Packer Plates will require M24 studding, see page 34.

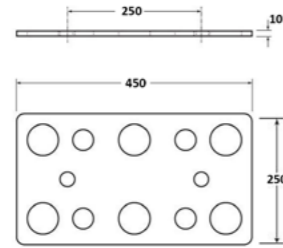

Product SKU	Size (mm)	Weight (kg)
6010899	450L x 250W x 10H	1.3
Material : NR/SBR		

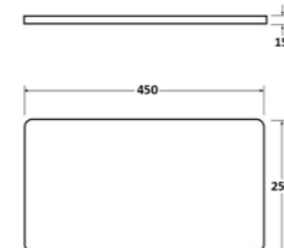
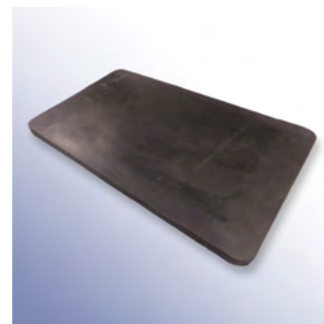

Product SKU	Size (mm)	Weight (kg)
6010900	450L x 250W x 15H	2.3
Material : NR/SBR		

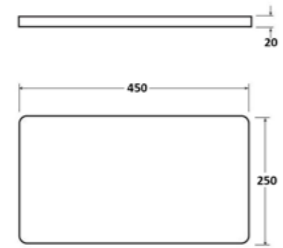
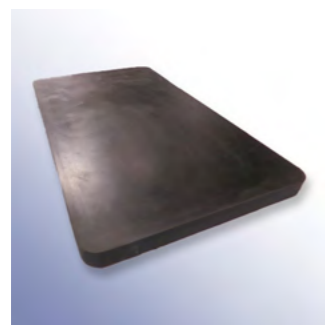

Product SKU	Size (mm)	Weight (kg)
6010901	450L x 250W x 20H	2.8
Material : NR/SBR		

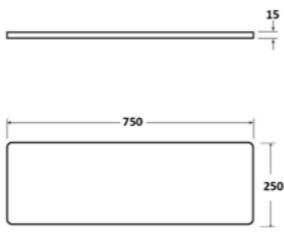
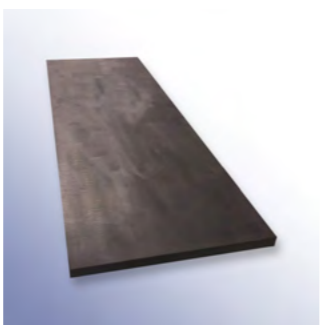

Product SKU	Size (mm)	Weight (kg)
6010904	750L x 250W x 15H	3.6
Material : NR/SBR		

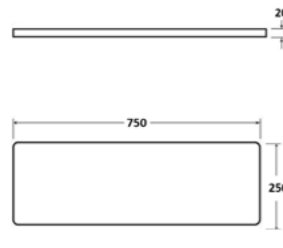
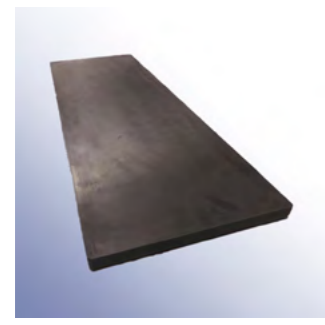

Product SKU	Size (mm)	Weight (kg)
6010905	750L x 250W x 20H	4.8
Material : NR/SBR		

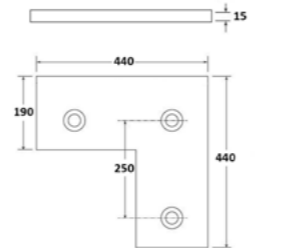

Product SKU	Size (mm)	Weight (kg)
6010903	450L x 450W x 15H	2.3
Material : NR/SBR		

Products continued on next page...

... Dock Bumper Placker Plates continued.

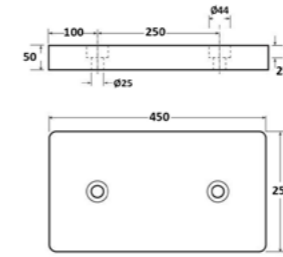

Product SKU	Size (mm)	Weight (kg)
6010902	450L x 250W x 50H	5.5
Material : NR/SBR		

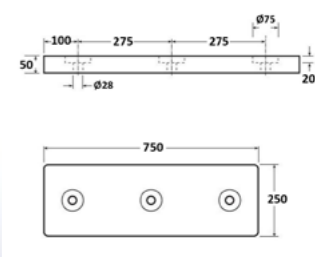

Product SKU	Size (mm)	Weight (kg)
6010906	750L x 250W x 50H	10.5
Material : NR/SBR		

Dock Bumper Back Plates

SPECIFICATIONS

- View all corresponding dock bumper parts on page 17.

PRODUCT OVERVIEW

Back Plates help improve the structural integrity of the Dock Bumper whilst making assembly much simpler. We highly recommend securing your Dock Bumpers to walls or dock levellers using a backing plate for additional protection and support.

Please note - The Three Part Set, High-Visibility and Slimline Dock Bumpers are sold with the back plate included. Attaching the Dock Bumpers to the Back Plate will require M24 studding, see page 34.

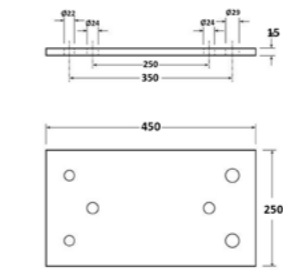
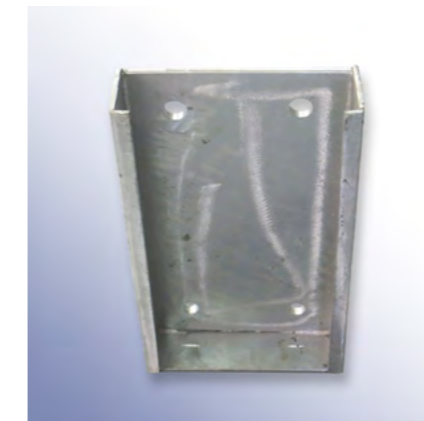

Product SKU	Size (mm)	Weight (kg)
6003200	450L x 250W x 15H	15
Material : Steel		

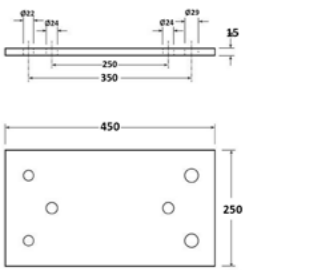

Product SKU	Size (mm)	Weight (kg)
6010907	450L x 250W x 15H	15
Material : Red Oxide Steel		

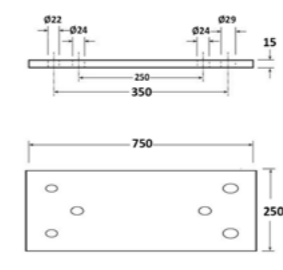

Product SKU	Size (mm)	Weight (kg)
6003202	750L x 250W x 15H	24
Material : Steel		

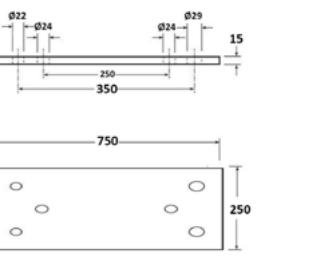

Product SKU	Size (mm)	Weight (kg)
6010919	750L x 250W x 15H	24
Material : Red Oxide Steel		

Products continued on next page...

... Dock Bumper Back Plates continued.

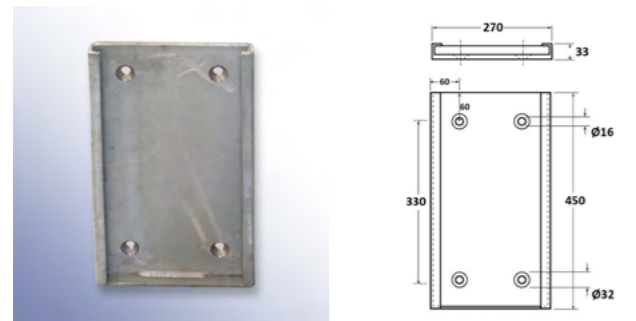

Product SKU	Size (mm)	Weight (kg)
6010908	450L x 270W x 33H	11
Material : Steel		

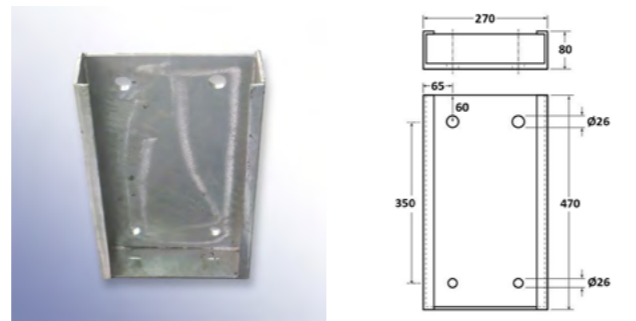

Product SKU	Size (mm)	Weight (kg)
6010909	470L x 270W x 80H	16.5
Material : Steel		

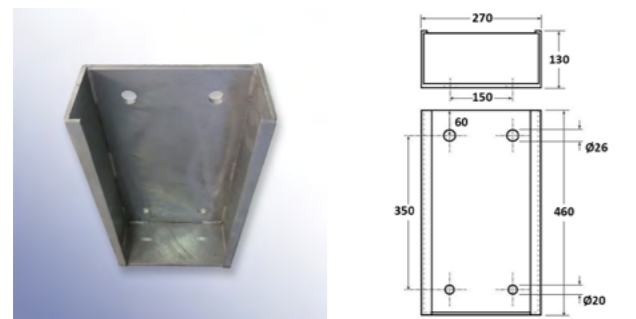

Product SKU	Size (mm)	Weight (kg)
6010910	470L x 270W x 120H	21
Material : Steel		

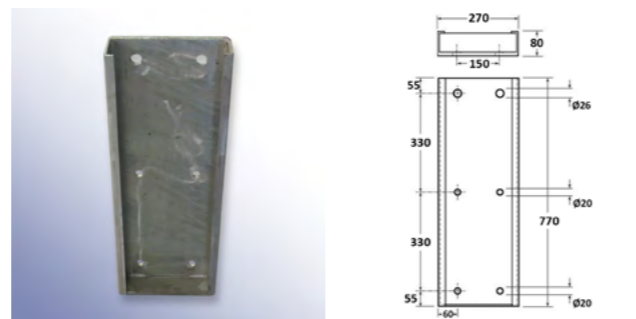

Product SKU	Size (mm)	Weight (kg)
6010911	770L x 270W x 80H	26
Material : Steel		

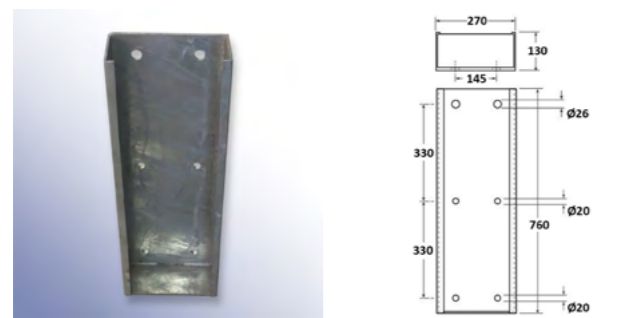

Product SKU	Size (mm)	Weight (kg)
6010912	770L x 270W x 120H	34
Material : Steel		

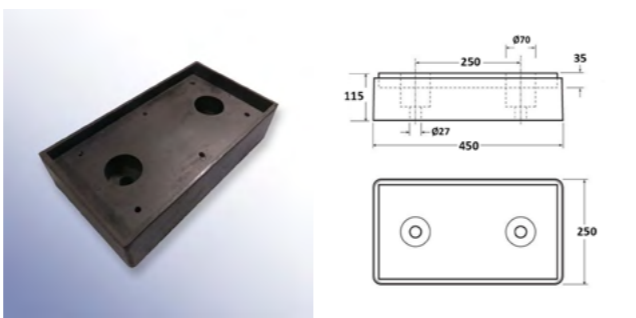

Product SKU	Size (mm)	Weight (kg)
6010917	450L x 250W x 100H	10
Material : (NR/SBR)		

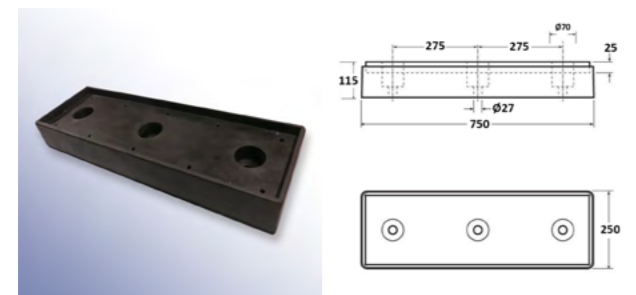

Product SKU	Size (mm)	Weight (kg)
6010918	750L x 250W x 100H	17
Material : (NR/SBR)		

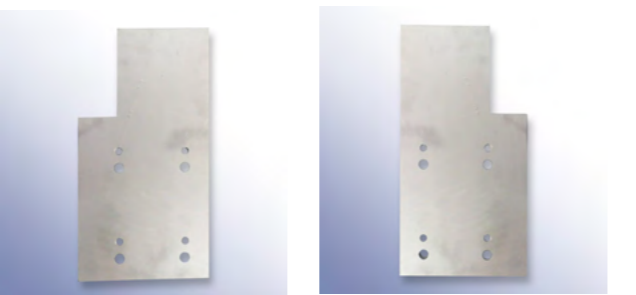

Product SKU	Size (mm)	Weight (kg)
Left: 6010913 Right: 6010914	750L x 400W x 100H	34
Material : Steel		



Spring-Loaded Back Plates

PRODUCT OVERVIEW

Our Spring-Loaded Back Plates are fully-compatible with a selection of 450mm and 750mm high dock bumpers. It allows the bumper to slide down as the trailer is loaded, returning when the trailer moves away. This is a great solution to help prevent trailers from overriding the Dock Bumper and damaging the property.

Product SKU	Type	Size (mm)	Weight (kg)
6010915	2 Holes	720L x 250W x 66H	32
6010916	3 Holes	965L x 250W x 66H	47

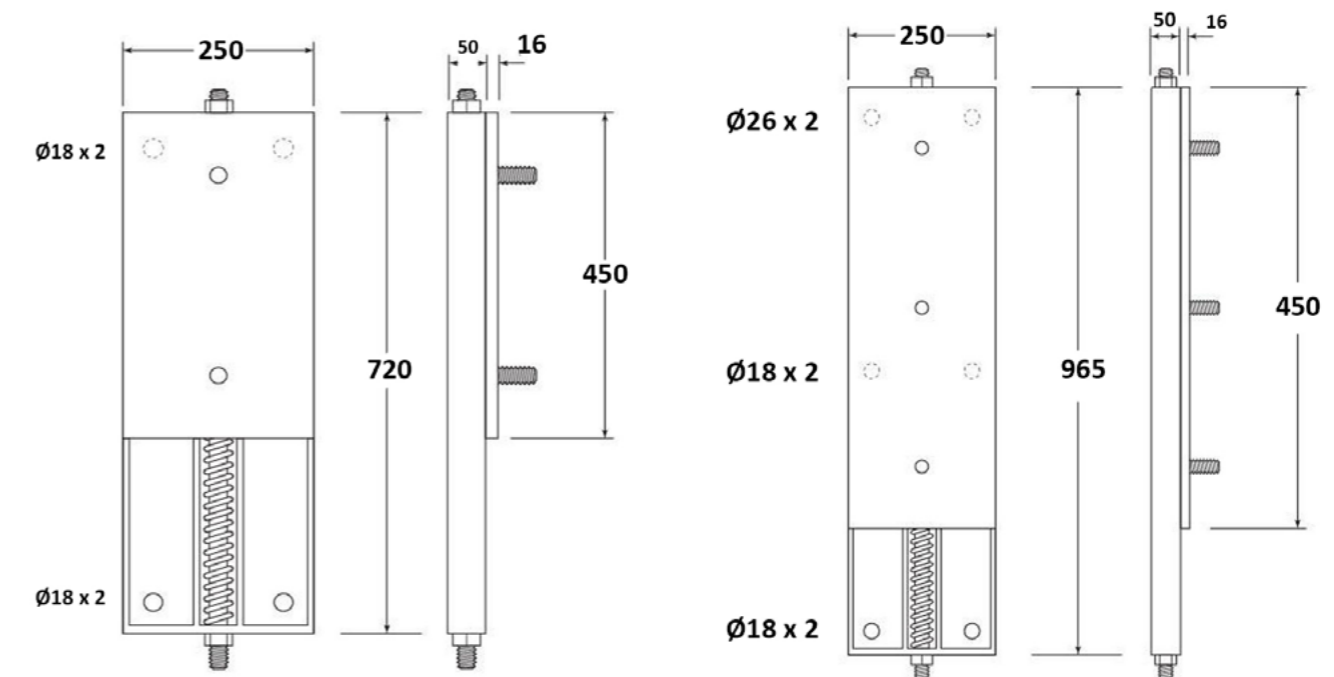

Get in Touch Today

Now that you've discovered everything you need to help protect your vehicles and building work against unwanted impacts, ordering couldn't be simpler. Get in touch today with one of our sales team by calling 01420 550598 or emailing sales@polymax.co.uk. Alternatively, why not head over to www.polymax.co.uk to view our full product range. We offer over 150,000 of the highest quality rubber products.

Remember, if it's made of rubber, we can supply it.

If you've enjoyed our service don't forget to leave us a 5-star review on Google, or let us know through our Twitter, Facebook or LinkedIn pages.





Building 75
Whitehill & Bordon Enterprise Park
Budds Lane, Bordon, Hampshire, GU35 0FJ

www.polymax.co.uk | sales@polymax.co.uk | +44 (0)1420 550598